

Splice, "endless" line

595-673
2003-08-21

1.

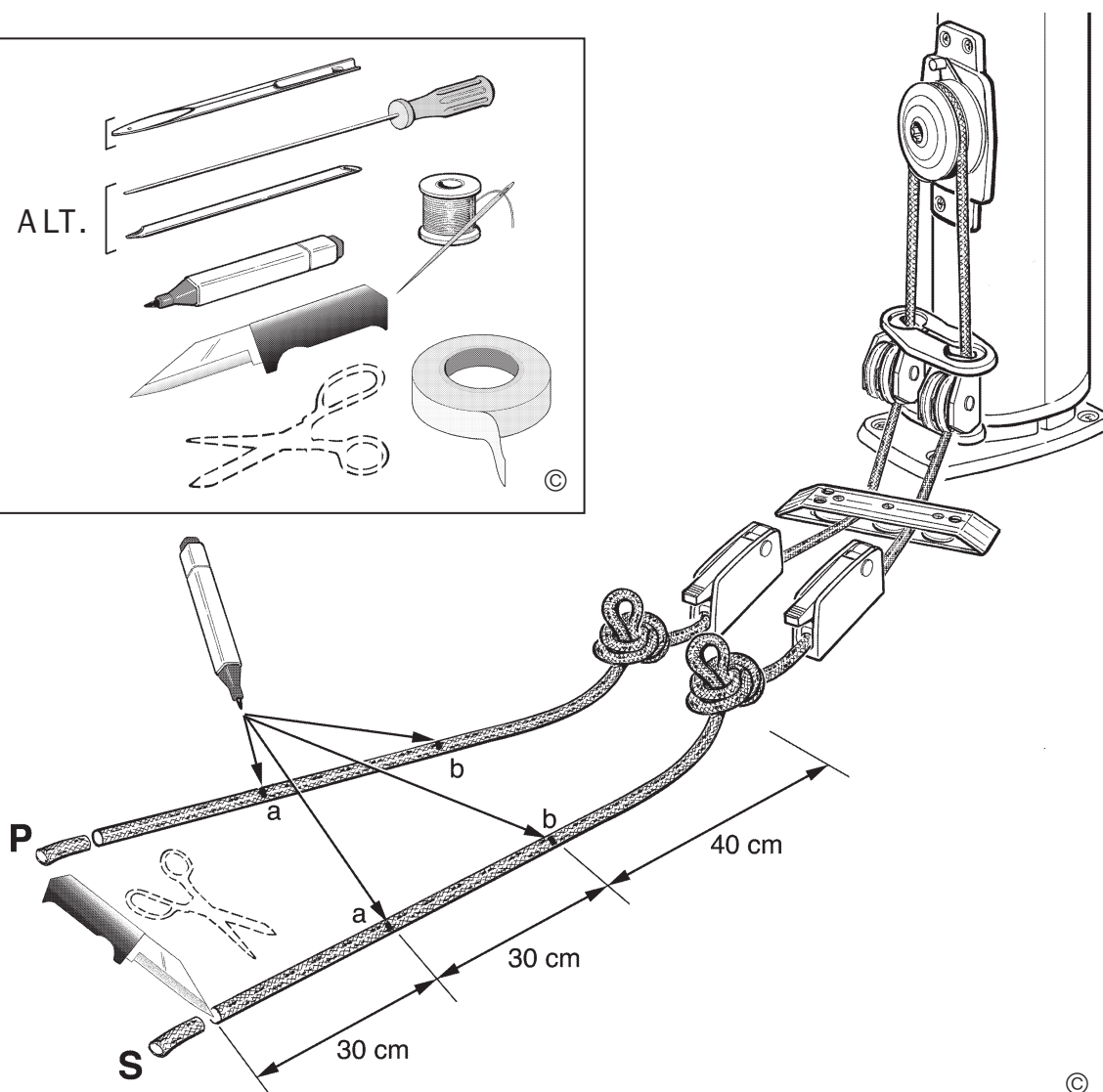
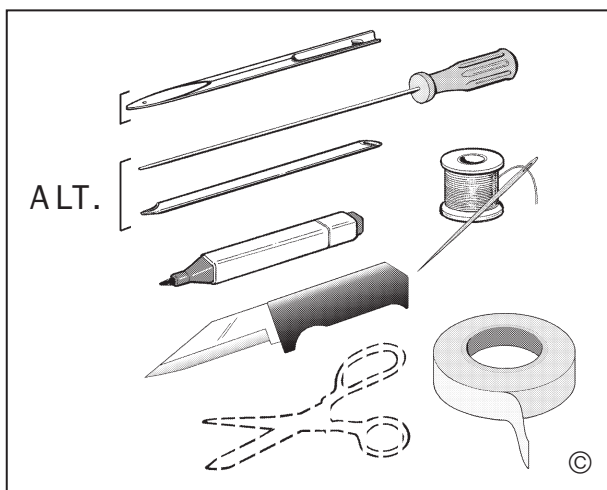

2.

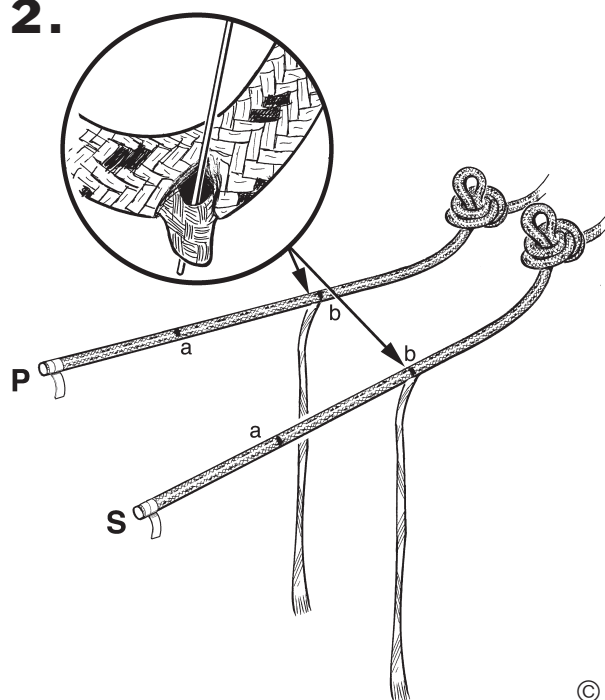

3a.

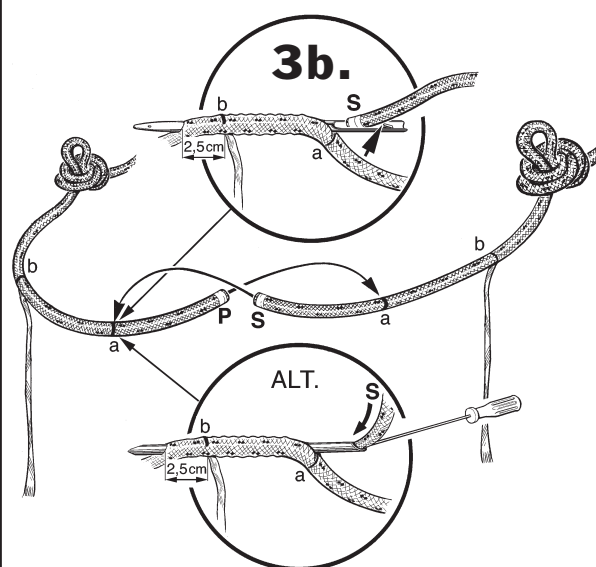

4.

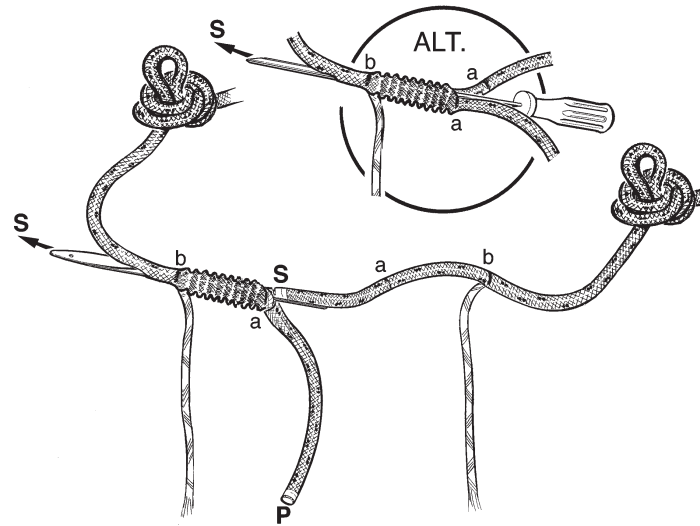

©

5.

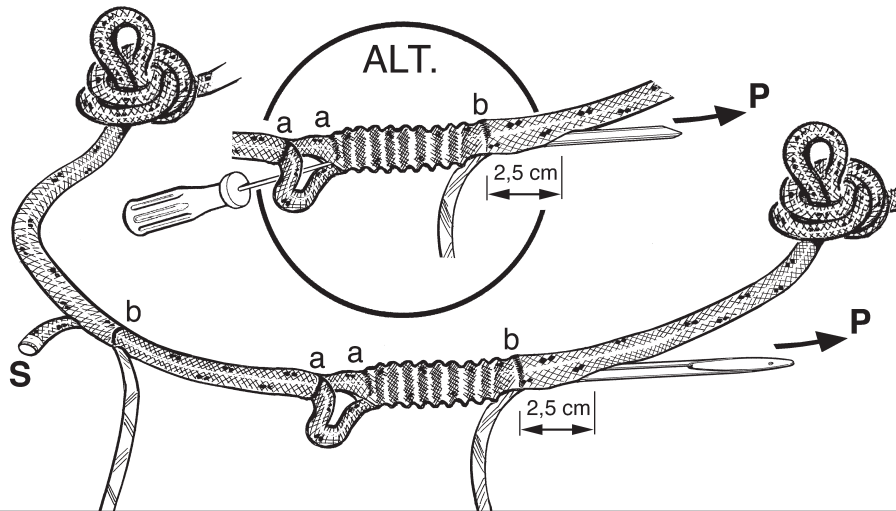

©

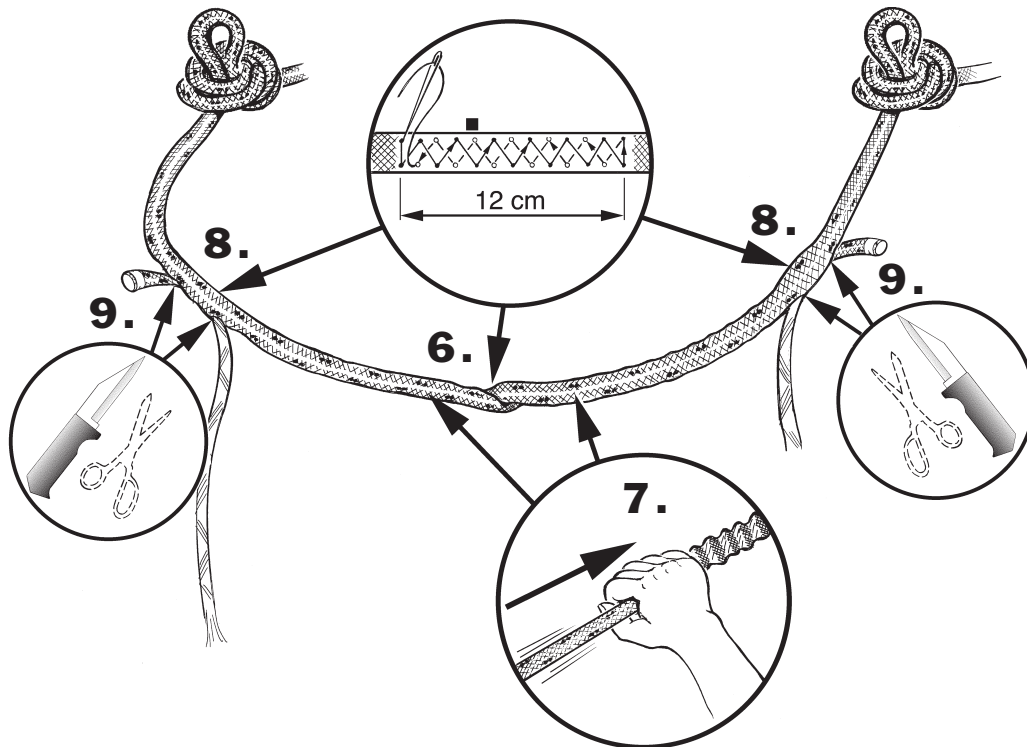

©

 **SELDÉN**

www.seldenmast.com

Sweden: Seldén Mast AB, Tel +46 (0)31 69 69 00, e-mail info@seldenmast.com UK: Seldén Mast Ltd., Tel +44 (0)1489 48 40 00, e-mail info@seldenmast.co.uk USA: Seldén Mast Inc., Tel +1 843-760-6278, e-mail info@seldenus.com Denmark: Seldén Mast A/S, Tel +45 39 18 44 00, e-mail info@seldenmast.dk the Netherlands: Seldén Mid Europe B.V., Tel +31 (0)111-698 120, e-mail info@seldenmast.nl